

Note!
Bemærk!
Achtung!

A noter
Attentie!
Obs!

¡Atención!
Attenzione!
Atenção!

Huomaa!
注意!
Προσοχή!

Внимание!
Megjegyzés!
Uwaga!

Dikkat!
Upozornění!
Pozor!

Opomba!
注意!
ملاحظة!



Wrong
Forkert
Falsch!

Faux
Fout!
Fel!

¡Incorrecto!
Sbagliato!
Errado!

Väärin!
啾、!
Λάθος!

Неправильно!
Hibás!
Nieprawidłowo!

Yanlış!
Špatně!
Nesprávne!

Napačno!
間違い!
خطأ!



Correct
Korrekt
Richtig!

Vrai
Goed!
Rätt!

¡Correcto!
Giusto!
Correto!

Oikein!
正确!
Σωστό!

Правильно!
Megfelelő!
Prawidłowo!

Doğru!
Správně!
Správne!

Pravilno!
正しい!
صحيح!

Declaration of Conformity

We, Jamo A/S
Elmevej 8
7870 Glyngøre
Denmark



Declare in own responsibility, that the Jamo product described in this instruction manual is in compliance with the corresponding technical standards such as EN60065, EN55013 and EN61000-3-2

Glyngøre, Denmark

Esben I. Noesgaard
Esben I. Noesgaard

1

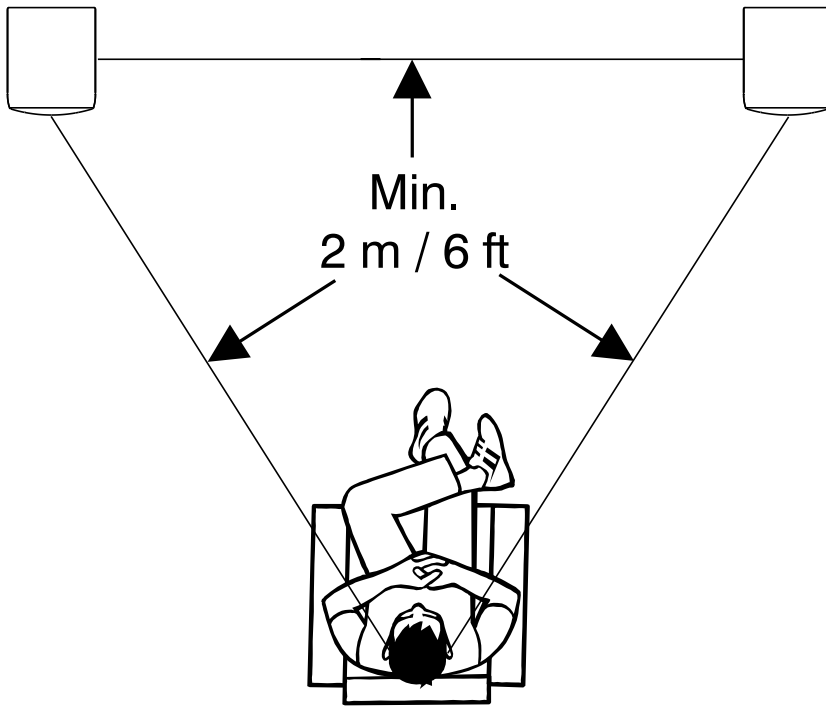

2

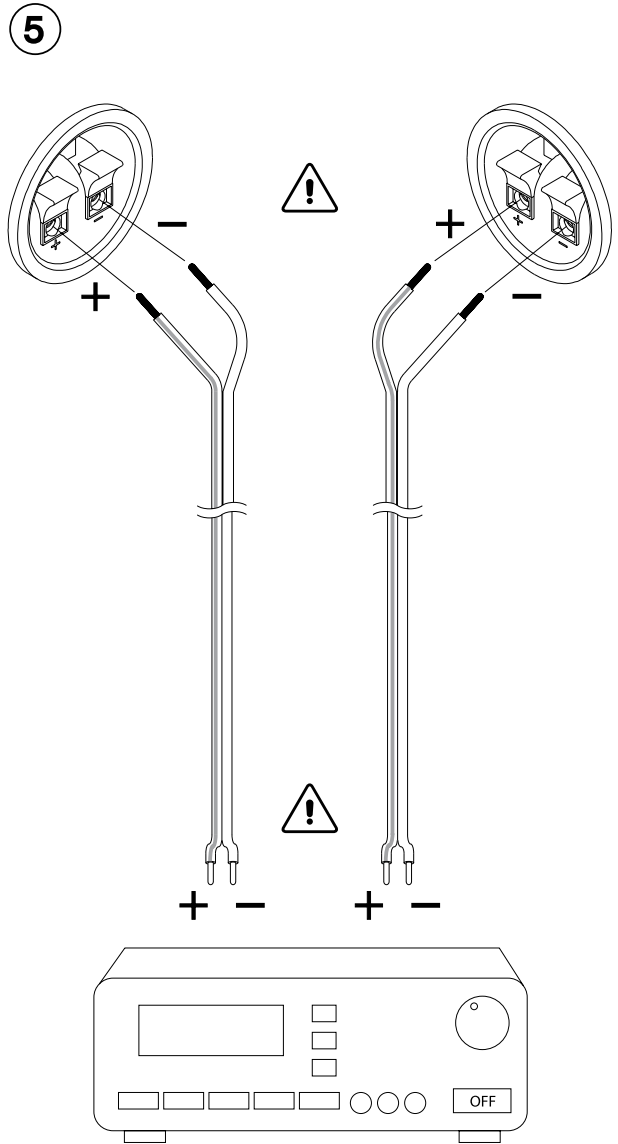
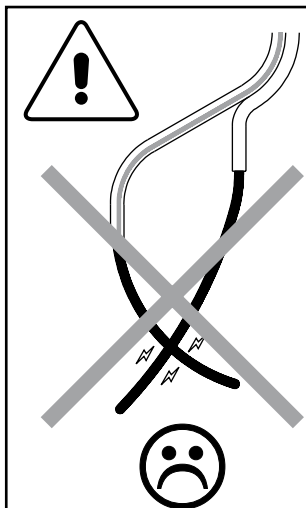
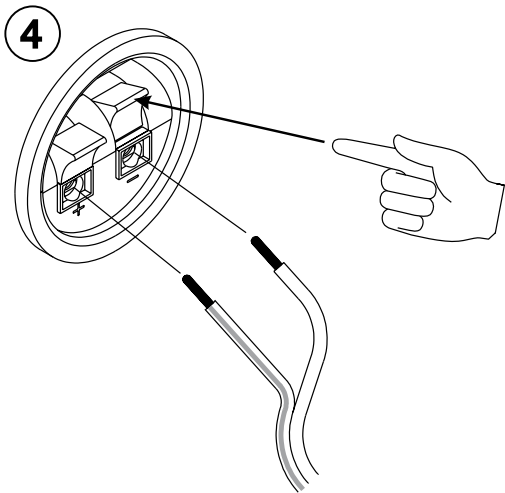
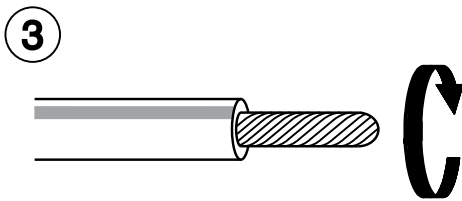
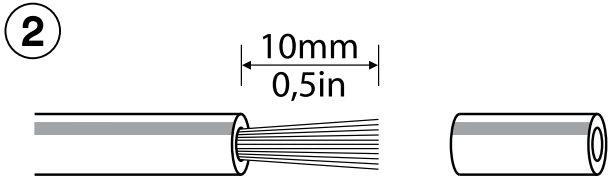
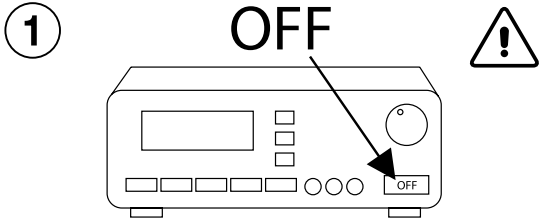

3

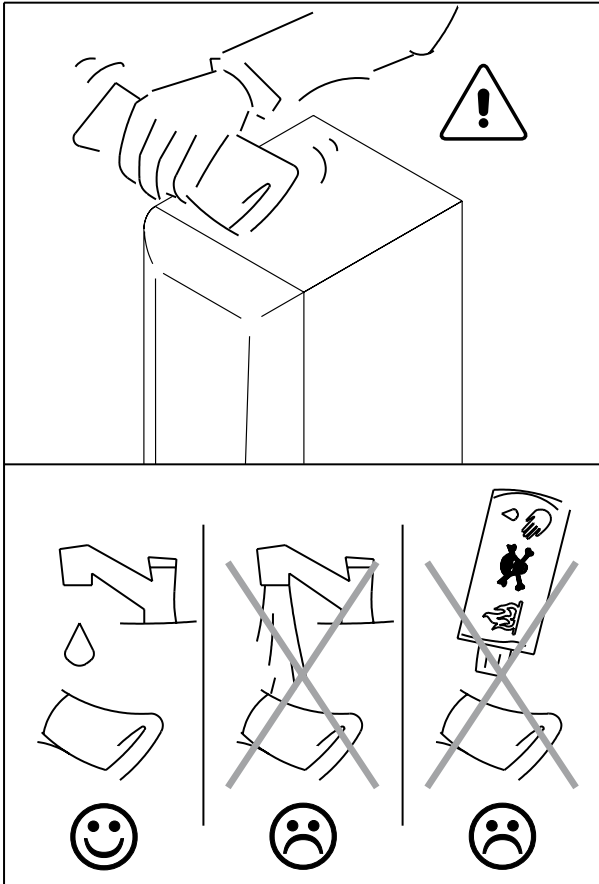

4

Type.....**E 430**
System.....3Way Bassreflex
Woofers.....6½" / 165 mm
Midrange.....3" / 76 mm
Tweeter.....2" / 50 mm
Power handling*.....70W / 120W
Frequency range.....55 - 20.000 Hz
Impedance.....4 Ohm
Dimensions.....800x192x255mm
31,5x7,6x10,0in
Weight.....7,1 kg / 15,7 lb

Type.....**E 470**
System.....3 Way Bassreflex
Woofers.....8" / 165 mm
Midrange.....3" / 76 mm
Tweeter.....2" / 50 mm
Power handling*.....100W / 170W
Frequency range.....50 - 20.000 Hz
Impedance.....4 Ohm
Dimensions.....900x232x280mm
35,4x9,1x11,0in
Weight.....10,7 kg / 23,6 lb

Specifications subject to technical changes.
*Long / Short term power, According to IEC 268-5.

English

The scope of the warranty

The warranty period will come into force as from the purchase date stated on the invoice. The warranty will apply for the following period of time:

- 2 years for electronics (power supply, amplifier, etc.)
- 7 years for other parts (cabinet, speaker units, etc.)

In case of warranty inquiries, please contact your dealer.

In case of request for service under warranty, please enclose your original receipt.

Defects covered by the warranty:

Except for the defects stated below, the warranty covers any production and material defects of the product.

Defects not covered by the warranty:

- Defects arising from accidents, misuse, normal wear and tear, mis-maintenance, voltage variation, overloading, stroke of lightning, and other force majeure events
- Defects arising from incorrect installation or operation
- Defects arising from modification/repair/attempt of repair by a non-authorized service centre
- Defects arising from the use of non-original spare parts
- Defects on products with altered or lacking series number
- Other defects due to conditions or circumstances beyond the supplier's control

Transportation costs for servicing are not covered by the warranty.

The supplier is liable only to repair or replace defective parts or products and the supplier is not responsible for indirect losses or damages arising from the use of the product. A replacement cannot exceed the value of the product under warranty.

To the extent that the enclosed conditions, including the limitation of liabilities, are inconsistent with indispensable regulations in the customer's country of residence, the latter shall have precedence.

Dansk

Garantiens omfang

Garantiperioden træder i kraft fra den på fakturaen påførte købsdato. Tidsrummet for garantiens dækning er som følger:

- 2 år for elektronikdele (strømforsyning, forstærker etc.)
- 7 år for andre dele (kabinet, højttaler-enheder etc.)

Alle henvendelser om garanti skal ske til forhandleren.

Ved anmodning om servicering under garanti skal original faktura medbringes.

Hvad omfatter garantien:

Med undtagelse af nedenstående dækker garantien alle fabrikations- og materialefejl på produktet.

Hvad omfatter garantien ikke:

- Fejl opstået som følge af uheld, misbrug, normalt slid, misligholdelse, spændingsudsving, overbelastning, lynnedslag og force majeure i øvrigt
- Fejl opstået som følge af ukorrekt installering eller betjening
- Fejl opstået som følge af modifikation/reparation/forøg på reparation foretaget af et ikke-autoriseret service center
- Fejl opstået i forbindelse med brugen af uoriginale reservedele
- Fejl på produkter med ændret eller manglende serienummer
- Fejl i øvrigt på grund af forhold eller omstændigheder, som leverandøren ikke er ansvarlig for

Omkostninger til transport i forbindelse med servicering er ikke omfattet af garantien.

Leverandøren er alene forpligtet til at udbedre eller omlevere fejlbehæftede dele eller produkter, og leverandøren er ikke ansvarlig for indirekte tab og/eller følgeskader i øvrigt ved brugen af produktet. Erstatningen kan ikke overstige værdien af det leverede.

I det omfang nærværende betingelser, herunder ansvarsbegrænsning m.v., måtte stride mod ufravigelige regler i kundens bopælsland har disse regler forrang i forholdet til nærværende bestemmelser.